

Eurotherm®

---

by **Schneider** Electric

# E Switch

## User Guide

Power Contactor

HA032323ENG issue 3

June 2017

部件名称 Part Name	有害物质 - Hazardous Substances					
	铅 (Pb)	汞 (Hg)	镉 (Cd)	六价铬 (Cr (VI))	多溴联苯 (PBB)	多溴二苯醚 (PBDE)
金属部件 Metal parts	0	0	0	0	0	0
塑料部件 Plastic parts	0	0	0	0	0	0
电子件 Electronic	X	0	0	0	0	0
触点 Contacts	0	0	0	0	0	0
线缆和线缆附件 Cables & cabling accessories	0	0	0	0	0	0

本表格依据SJ/T11364的规定编制。

O: 表示该有害物质在该部件所有均质材料中的含量均在GB/T 26572规定的限量要求以下。

X: 表示该有害物质至少在该部件的某一均质材料中的含量超出GB/T 26572规定的限量要求。

This table is made according to SJ/T 11364.

O: indicates that the concentration of hazardous substance in all of the homogeneous materials for this part is below the limit as stipulated in GB/T 26572.

X: indicates that concentration of hazardous substance in at least one of the homogeneous materials used for this part is above the limit as stipulated in GB/T 26572

Signed (Kevin Shaw, R&D Director):



Date:

24th June 2016

Power solid state contactors

# ESwitch Series

For the control of heating elements up to 25kW

## User Guide

Before installation, please read this manual thoroughly.

Eurotherm cannot be held responsible for any damage to persons or property, or for any financial loss or costs arising from incorrect use of the product or failure to observe the instructions given in this manual.

In order to maintain its 'leading edge' Eurotherm may have to make changes to its specifications without advance notice.

For any further information, or if in doubt, please contact Eurotherm, where qualified staff are available to advise or assist you with the commissioning of your installation.

Guarantee

Two years parts and labour guarantee

## Contents List

1. Safety Information	5
1.1 Important Information	5
2. Safety Notes	6
2.1 SELV	11
2.2 Symbols used in the Instrument Labelling	11
3. Technical specifications	12
4. Codification	18
4.1 Ordering Code	18
4.2 Fuses	19
5. Mechanical installation	20
5.1 Dimensional details	20
5.2 Front fascia	21
6. Electrical Installation	22
6.1 Terminals and Connectors	22
6.2 Connectors	24
6.2.1 View on lower face	24
6.2.2 View on upper face	24
7. Wiring	25
7.1 Input signal wiring	25
8. Partial Load Failure option (only available with LGC input)	26
8.1 Operations	26
8.2 Setting up the PLF detection	27
9. Thyristors firing modes - Logic mode	28
10. Current derating	29

## 1. SAFETY INFORMATION

### 1.1 Important Information

Read these instructions carefully and look at the equipment to become familiar with the device before trying to install, operate, service, or maintain it. The following special messages may appear throughout this manual or on the equipment to warn of potential hazards or to call attention to information that clarifies or simplifies a procedure.



The addition of either symbol to a “Danger” or “Warning” safety label indicates that an electrical hazard exists which will result in personal injury if the instructions are not followed.



This is the safety alert symbol. It is used to alert you to potential personal injury hazards. Obey all safety messages that follow this symbol to avoid possible injury or death.

#### **DANGER**

**DANGER** indicates a hazardous situation which, if not avoided, will result in death or serious injury.

#### **WARNING**

**WARNING** indicates a hazardous situation which, if not avoided, could result in death or serious injury.

#### **CAUTION**

**CAUTION** indicates a hazardous situation which, if not avoided, could result in minor or moderate injury.

#### **NOTICE**

**NOTICE** is used to address practices not related to physical injury.

## 2. Safety Notes



### **BRANCH-CIRCUIT PROTECTION AND SAFETY OVERLOAD PROTECTION**

1. This product does not contain any branch-circuit protection or internal safety overload protection. It is the responsibility of the user to add branch-circuit protection upstream of the unit. It is also the responsibility of the user to provide external or remote safety overload protection to the end installation. Such branch-circuit and safety overload protection must comply with applicable local regulations.

UL: The above mentioned branch-circuit protection is necessary for compliance with National Electric Code (NEC) requirements.

### **HAZARD OF ELECTRICAL SHOCK, EXPLOSION OR ARC FLASH**

2. Eurotherm shall not be held responsible for any damage, injury, losses or expenses caused by inappropriate use of the product or failure to comply with these instructions.
3. If the product is used in a manner not specified by the manufacturer the protection provided by the product might be impaired.
4. Disassembling the product is strictly forbidden.
5. The product must be installed and maintained by suitably qualified personnel, authorized to work in an industrial low voltage environment.
6. This product is not suitable for isolation applications, within the meaning of EN60947-1.

 **DANGER**

**HAZARD OF ELECTRICAL SHOCK, EXPLOSION OR ARC FLASH**

7. It is strongly recommended that the installing authority includes independent, system-safety mechanisms to protect both personnel and equipment against injury or damage, and that such safety mechanisms be regularly inspected and maintained. Consult the ESwitch supplier for advice.
8. The product is designed to be installed in a cabinet connected to the protective earth ground according to IEC60364-1 and IEC60364-5-54 or applicable national standards.
9. Electrically conductive pollution must be excluded from the cabinet in which the product is mounted. To ensure a suitable atmosphere in conditions of conductive pollution, fit adequate air conditioning/filtering/cooling equipment to the air intake of the cabinet, e.g. fitting fan-cooled cabinets with a fan failure detection device or a thermal safety cut-out.
10. Before carrying out any wiring to the product, it must be ensured that all relevant power and control cables, leads or harnesses are isolated from voltage sources.
11. Before any other connection is made, the protective earth ground terminal shall be connected to a protective conductor. Wire conductor cross sections must comply with table 9 of IEC60947-1 or NEC Article 310 Table 310-16.  
UL: The earth connection must be made using a UL-listed ring type crimp. The cable used must be rated 90°C stranded copper only.

 **DANGER**

12. The protective earth ground connections and power terminals must be tightened according to the torque values listed in table(s), see «6.1 Terminals and connectors», page 22. Appropriate regular inspections must be performed.
13. Any interruption of the protective earth ground conductor inside or outside the product, or disconnection of the protective earth ground terminal is likely to make the product dangerous under some conditions. Intentional interruption is prohibited. Whenever it is likely that protection has been impaired, the unit shall be made inoperative and secured against accidental operation. The manufacturers nearest service centre must be contacted for advice.
14. Power connections: wire conductor cross sections must comply with table 9 of IEC60947-1 or NEC Article 310 Table 310-16. The cables used must be rated 90°C stranded copper only.
15. According to the CE and UL certifications, high speed fuses (supplemental fuses) are mandatory for compliant installation and protection of the Eswitch controller against short circuit. See paragraph 4.2 for details.
16. With supplemental fuse (high speed fuse) the product's rated short-circuit conditional current is 100kA for co-ordination type 1. If opening of either the branch circuit protective or the supplemental (high speed) fuses occurs, the product must be examined by suitably qualified personnel and replaced if damaged.
17. Connection of two conductors in the same terminal is not permitted.

**Failure to follow these instructions will result in death or serious injury.**



 **WARNING**

1. Signal and power voltage wiring must be kept separate from one another. Where this is impractical, all wires have to be rated to the power voltage & shielded cables are recommended for signal wiring.
2. The instrument shall have one of the following as a disconnecting device, fitted within easy reach of the operator and labelled as the disconnecting device:
  - A switch or circuit breaker which complies with the requirements of IEC60947-1 and IEC60947-3
  - A separable coupler which can be disconnected without the use of a tool
3. The product is designed to be mounted vertically. There must be no obstructions (above or below) which could reduce or hamper airflow. If more than one instance of the product is located in the same cabinet, they must be mounted in such a way that air from one unit is not drawn into another.
4. To reach the thermal performance the gap between two ESwitch power contactors must be at minimum 10mm.
5. Under some circumstances, the heatsink temperature may rise by more than 50°C and it can take up to 15 minutes to cool after the product is shut down. Give consideration to additional warnings and barriers to prevent injury.
6. This product has been designed for environment A (Industrial). Use of this product in environment B (domestic, commercial and light industrial) may cause unwanted electromagnetic disturbances in which case the installer may be required to take adequate mitigation measures.

 **WARNING**

7. To ensure that ESwitch complies with Electromagnetic Compatibility requirements, ensure that the panel or DIN rail to which it is attached is correctly grounded. The ground connection, designed to ensure ground continuity, is not in any way a substitute for the protective earth ground connection.
8. IP20: In order to maintain IP20 protection, the stripped length of the power cables from the supply and to the load must be adapted according to the insulation thickness.

**Failure to follow these instructions can result in death, serious injury or equipment damage.**

## 2.1 SELV









Safety Extra Low Voltage. This is defined (in IEC60947-1) as an electrical circuit in which the voltage cannot exceed 'ELV' under normal conditions or under single fault conditions, including earth faults in other circuits. The definition of ELV is complex as it depends on environment, signal frequency, etc. See IEC 61140 for further details.

The connector (pin 5 to 6) of logic input dc (LGC) and low voltage ac input (LAC) are compliant to the SELV requirements.



Alarm relay contacts terminals 7 and 8 (PLF/IPF option only) are compliant to the SELV requirements; they can be connected to SELV or to voltage up to 230V (Rated insulation voltage  $U_i$ : 230V).

## 2.2 SYMBOLS USED IN THE INSTRUMENT LABELLING

One or more of the symbols below may appear as a part of the instrument labelling.

	Protective conductor terminal		Risk of electric shock
	AC supply only		Precautions against static electrical discharge must be taken when handling this unit
	Underwriters Laboratories listed mark for Canada and the US		Refer to the manual for instructions
	Do not touch Heatsink Hot Surface		CE Mark. Indicates compliance with the appropriate European Directives and Standards
	EAC (EurAsian Conformity) customs union mark of conformity		

### 3. Technical specifications

<b>General</b>	
Device form designation	Form 5: Semiconductor DOL (Direct On Line) Contactor
Rated Duty	Uninterrupted duty/continuous operation
Directive	EMC directive 2014/30/EU Low Voltage Directive 2014/35/EU RoHS Directive 2011/65/EU
Safety specification	EN60947-4-3:2014
EMC emissions specification	Low-voltage switchgear and controlgear - Part 4-3: Contactors and motor-starters). AC semiconductor controllers and contactors for non-motor loads (identical to IEC60947-4-3:2014)
EMC immunity specification	
<b>Approvals</b>	
	UL 60947-4-1 and CSA C22.2 NO. 60947-4-1-14, Low-Voltage Switchgear and Controlgear - Part 4-1: Contactors and Motor-Starters - Electromechanical Contactors and Motor-Starters
	EN 60947-4-3:2014 (Low-voltage switchgear and controlgear — Part 4-3: Contactors and motor-starters — AC semiconductor controllers and contactors for non-motor loads (identical to IEC60947-4-3:2014)
	EAC (EurAsian Conformity) customs union mark of conformity
Protection	CE: IP20 according to EN60529 UL: Open type

<b>Installation Category</b>				
	Installation category	Rated impulse withstand voltage (Uimp)	Rated insulation voltage (Ui)	Maximum value of rated operational voltage to earth
Command signal terminals 5 and 6 LGC or LAC input	III	0.8kV	50V	50V
Command signal terminals 5 and 6 HAC input	III	4kV	250V	250V
Alarm relay contacts terminals 7 and 8 (PLF/IPF option only)	III	4kV	250V	250V
Power terminals 1/L1, 3/L2, 2/T1 and 4/T2	III	6kV	500V	500V
<b>Condition of use</b>				
Atmosphere	Non-corrosive, non-explosive, non-conductive			
Usage temperature	0 to 45°C at 1000m 0 to 40°C at 2000m Please refer to paragraph 10 for derating information			
Storage temperature	-25°C to 70°C (maximum)			
Altitude	1000m maximum at 45°C 2000m maximum at 40°C Please refer to paragraph 10 for more details			
Degree of pollution	Degree 2			
Humidity limits	5% to 95% RH (non-condensing)			

<b>Mechanical Details</b>	
Dimensions	
Without PLF	
Model 16 amps	115mm (Height) x 36.8mm (Width) x 92.5mm (Depth)
Model 25 amps	115mm (Height) x 54.3mm (Width) x 92.5mm (Depth)
Model 40 amps	115mm (Height) x 89.3mm (Width) x 92.5mm (Depth)
Model 50 amps	115mm (Height) x 106.8mm (Width) x 92.5mm (Depth)
With PLF	
Model 16 amps	115mm (Height) x 52.5mm (Width) x 92.5mm (Depth)
Model 25 amps	115mm (Height) x 70mm (Width) x 92.5mm (Depth)
Model 40 amps	115mm (Height) x 105mm (Width) x 92.5mm (Depth)
Model 50 amps	115mm (Height) x 122.5mm (Width) x 92.5mm (Depth)
Mounting	DIN rail
<b>Power</b>	
Nominal current (rated operational current: $I_e$ )	16A, 25A, 40A, 50A; refer to paragraph 4. Codification
Nominal voltage (rated operational voltage: $U_e$ )	According to Nominal voltage codification: 120V : 100V -15% to 120V +10% 240V : 200V -15% to 240V + 10% 500V : 380V -15% to 500V +10% Refer to 'Codification' for more details
Frequency	47Hz to 63Hz
Rated conditional short-circuit current	100kA (co-ordination type 1)
Type of Loads (utilization category)	AC51: Non-inductive or slightly inductive loads, resistance furnaces
Supply of electronics	Self powered product ( $U_s = U_e$ )
Overload current profile	AC51: 1 x $I_e$ continuous

<b>Control</b>	
<p>Command signal</p> <ul style="list-style-type: none"> <li>Rated control circuit voltage (UC)</li> <li>Logic dc (LGC)</li> <li>Logic ac Low Voltage (LAC)</li> </ul> <p>Logic ac High Voltage (HAC)</p> <ul style="list-style-type: none"> <li>Rated control circuit current</li> <li>Logic dc (LGC)</li> </ul>	<p>Logic signal either dc or ac - Polarity insensitive: + and – can be crossed - Command signal indication by green LED</p> <p>5 to 32Vdc (ON &gt;5V, OFF &lt;2V) 30 to 55Vac (ON &gt;30V, OFF &lt;5V)</p> <p>If a protection RC snubber is used across a relay contact circuit or an optotriac, maximum capacitor value is 47nF for 48Vac 85 to 264Vac (ON&gt;85V, OFF&lt;10V)</p> <p>If a protection RC snubber is used across a relay contact circuit or an optotriac, maximum capacitor value is 10nF for 240Vac</p> <p>10 to 20mA dc (ON&gt;8mA, OFF&lt;0.5mA)</p>
<b>PLF output</b>	
<p>Alarm relay contact</p> <ul style="list-style-type: none"> <li>Current rating</li> <li>Min switching current</li> </ul>	<p>0.5A</p> <p>10mA (For compatibility with PLC input, additional external load may be required.)</p>
<b>EMC</b>	
Test Results	See table A2a

<b>EMC immunity tests (According to EN60947-4-3:2014)</b>				
Tests	Level		Criteria	
	Requested	Achieved	Requested	Achieved
Electrostatic discharge (test method given in IEC 61000-4-2)	Air discharge mode 8kV Contact discharge mode 4kV	Air discharge mode 8kV Contact discharge mode 4kV	2	1
Radiated radio-frequency electromagnetic field test (test method of EN 61000-4-3)	10V/m from 80MHz to 1GHz and 1.4GHz to 2GHz	12V/m from 80MHz to 3GHz	1	1
Fast transient/burst test (5/50ns) (test method of EN 61000-4-4)	Power ports 2kV / 5kHz	Power ports 4kV / 5 kHz	2	1
	Signal ports 1kV / 5kHz	Signal ports 4kV / 5kHz	2	1
Surge Voltage test (1,2/50 $\mu$ s – 8/20 $\mu$ s) (test method of EN 61000-4-5)	2kV line to earth 1kV line to line	2kV line to earth 1kV line to line	2	1
Conducted radio-frequency test (test method of EN 61000-4-6)	10V (140dB $\mu$ V) from 0.15MHz to 80 MHz	13V (142dB $\mu$ V) from 0.15MHz to 80 MHz	1	1
Voltage dips test (test method of EN 61000-4-11)	0% during 0.5 cycle & 1 cycle	0% during 0.5 cycle & 1 cycle	2	2
	40% during 10/12 cycles	40% during 10/12 cycles	3	2
	70% during 25/30 cycles	70% during 25/30 cycles	3	2
	80% during 250/300 cycles	80% during 250/300 cycles	3	2
Short interruptions test (test method of EN 61000-4-11)	0% during 250/300 cycles	0% during 250/300 cycles	3	2

Table A2a1 EMC immunity tests



EMC emission tests (According to EN60947-4-3:2014)				
Test	Frequency (MHz)	Limit level for class A industrial		Comments
		Quasi peak dB ( $\mu$ V)	Average dB ( $\mu$ V)	
Radiated radio frequency emission test According to EN60947-4-3:2014 (Test method CISPR11)	30 to 230	50 at 3m	N/A	Pass
	230 to 1000	57 at 3m	N/A	Pass
Conducted radio frequency emission test According to EN 60947-4-3:2014 for rated power <20kVA (test method of CISPR11)	0.15 to 0.5	79	66	The conducted emissions can meet the requirement of IEC60947-4-3:2014 with an external filter added on the line connections.
	5 to 30	73	60	
Conducted radio frequency emission test According to EN 60947-4-3:2014 for rated power >20kVA (test method of CISPR11)	0.15 to 0.5	100	90	This is in line with the rest of the industry <sup>1</sup>
	0.5 to 5	86	76	
	5 to 30	90 to 73	80 to 60	
<p><b>Note:</b> This product has been designed for environment A (Industrial). Use of this product in environment B (domestic, commercial and light industrial) may cause unwanted electromagnetic disturbances in which cases the user may be required to take adequate mitigation measures.</p>				

1. Technical note TN1618 (available upon customer request) describes the recommended filter structures which reduce conducted radio-frequency emissions.

Table A2a2 EMC Radiated Emissions test

## 4. Codification

### 4.1 Ordering Code

Model /Nominal Current/Nominal Voltage/Input /Language/Partial Load Failure/Fuse/Special description.

Model	
ESwitch	ESWITCH
Nominal Current	
16 amps	16A
25 amps	25A
40 amps	40A
50 amps	50A
Nominal Voltage	
120 volts	120V
240 volts	240V
500 volts	500V
Input	
Logic dc input (5-32V)	LGC
Low voltage ac (48Vac)	LAC
High voltage ac (100-240Vac)	HAC

Language	
English	ENG
French	FRA
German	GER
Partial load failure <sup>(note 1)</sup>	
Without Partial load failure	-
Relay contact open on alarm	PLF
Relay contact closed on alarm	IPF
Fuse	
Without fuse <sup>(note 2)</sup>	NOFUSE
With fuse without microswitch	FUSE
With fuse with microswitch	MSFUSE
Special description	
No special	

<sup>1</sup> Option available only with LGC input

<sup>2</sup> See 4.2

## 4.2 Fuses

**DANGER:** This product does not contain any branch-circuit protection or internal safety overload protection. Please refer to Danger para 1, page 6.

According to the CE and UL certifications, high speed fuses (supplemental fuses) are mandatory for compliant installation and protection of the ESwitch Power Contactor against short circuit.

The power circuit shall be protected by a supplemental fuse as described in the table below. These should be used in conjunction with suitable fuse holders and contact kits (if required) as shown in this table.

With supplemental fuse (high speed fuse), ESwitch is suitable for use on a circuit capable of delivering not more than 100kA RMS symmetrical amperes, 500 Volts maximum. (coordination Type 1).

**DANGER:** If either the branch circuit protection or the supplemental (high speed) fuses are opened, ESwitch shall be examined and replaced if damaged. Please refer to 1.1 Important Information, page 5.

		Fuse body size (mm)	Fuse holder part no.	Fuse part no.	Contact kit part no.
16A	w/o MS	10x38	CP018525	CS031505U002	
	with MS	14x51	CP171480	CS031506U002	CP177220
25A	w/o MS	10x38	CP018525	CS031505U002	
	with MS	14x51	CP171480	CS031506U002	CP177220
40A	w/o MS	14x51	CP171480	CS031509U002	
	with MS	14x51	CP171480	CS031510U002	CP177220
50A	w/o MS	22x58	CP173083	CS031511U002	
	with MS	22x58	CP173083	CS031512U002	CP177221

## 5. Mechanical installation

### 5.1 Dimensional details

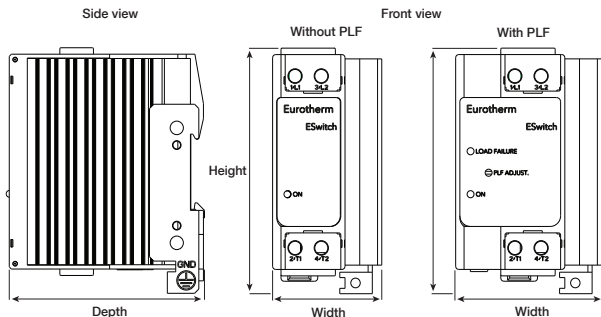

Model	Height (mm)	Width (mm)		Depth (mm)
		without PLF	with PLF	
16A	115	36,8	52,5	92,5
25A	115	54,3	70	92,5
40A	115	89,3	105	92,5
50A	115	106,8	122,5	92,5

**WARNING:** To reach the thermal performance the gap between two ESwitch power contactors must be at minimum 10mm.

**WARNING:** To ensure that ESwitch complies with Electromagnetic Compatibility requirements, ensure that the panel or DIN rail to which it is attached is correctly grounded. The ground connection, designed to ensure ground continuity, is not in any way a substitute for the protective earth ground connection.

## 5.2 Front fascia

Power terminals :

Terminals 1L1 & 2/T1 : Controlled Phase - Terminals 3/L2 & 4/T2 : Direct phase

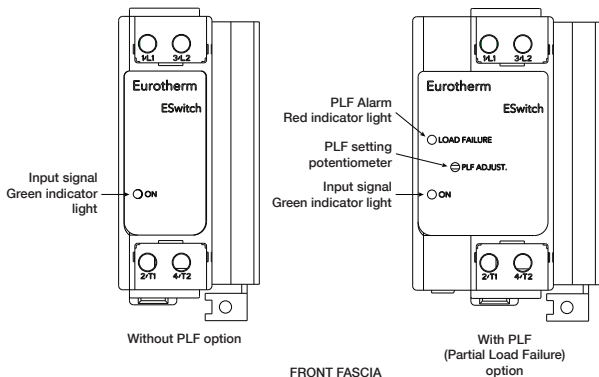

## 6. Electrical Installation

### 6.1 Terminals and connectors

**DANGER:** Before carrying out any wiring to the product, it must be ensured that all relevant power and control cables, leads or harnesses are isolated from voltage sources.

The tables below give details of wire sizes and tightening torques for both power and signal wiring connection.

**DANGER:** The protective earth ground connections and power terminals must be tightened according to the torque values listed in tables below. Appropriate regular inspections must be performed.

Wire conductor cross sections must comply with table 9 of IEC60947-1 (or NEC, Article 310 Table 310-16). Where a range of wire sizes is given it is up to the user to select the correct cross sectional area required for the application.

The protective earth ground cable should be, as a minimum, of the same cross sectional area as the cables used for the Mains and Load cables (i.e. the cables terminated at the 1/L1, 3/L2, 2/T1 and 4/T2 terminals).

UL: The protective earth ground connection must be made using a UL Listed ring type crimp.

## POWER TERMINALS

Terminal	Function	Terminal type	Cable	Stripping	Tightening torque	Screw driver details
1/L1	Mains - Controlled phase	Cage	1.5mm <sup>2</sup> to 16mm <sup>2</sup> (14 to 6 AWG) rated 90°C	16mm	CE: 2.3 N.m  UL: 20.4 lb.inch	1 x 5.5mm
3/L2	Mains - Direct phase/Neutral					
2/T1	Load - Controlled phase					
4/T2	Load - Direct phase/Neutral					
	Protective earth ground	M5 screw	Same section as Mains and Load cables minimum rated 90°C	The protective earth ground connection must be made using a UL Listed ring type crimp		

## CONTROL BOARD CONNECTORS

Terminal	Function	Connector type	Cable	Stripping	Tightening torque	Screw driver details
5	Command signal	Plug-in	0.25 to 2.5mm <sup>2</sup> (24 to 12 AWG) rated 75°C	7mm	CE: 0.6 N.m  UL: 5 lb.inch	0.6 x 3.5mm
6	Command signal					
7 and 8	PLF contact (option)					

**DANGER:** Connection of two conductors in the same terminal is not allowed. Failure to follow these instructions will result in death, serious injury or equipment damage.

**WARNING:** Signal and power voltage wiring must be kept separate from one another. Where this is impractical, all wires have to be rated to the power voltage & shielded cables are recommended for signal wiring.

## 6.2 Connectors

### 6.2.1 View on lower face

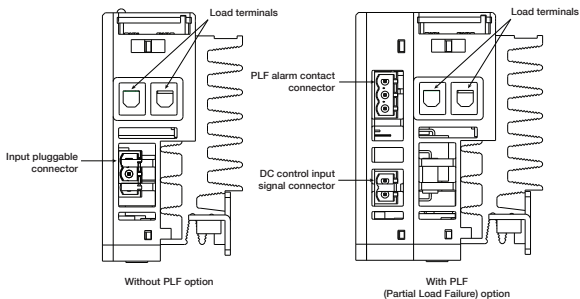

### 6.2.2 View on upper face

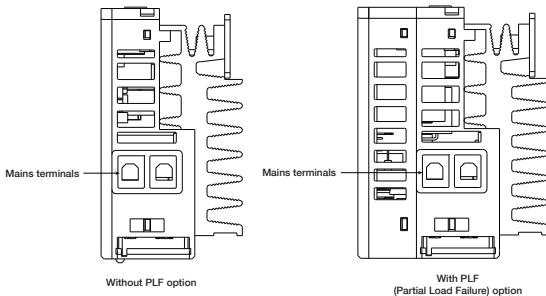



## 7. Wiring

### 7.1 Input signal wiring

Example with an ESwitch with PLF option driven by a logic signal coming from the temperature controller.

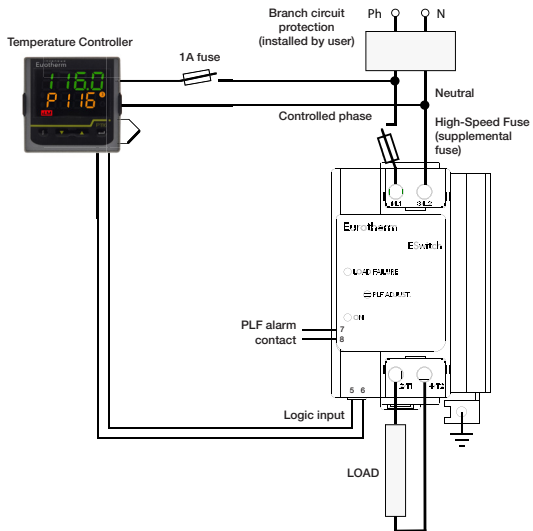

## **8. Partial Load Failure option (only available with LGC input)**

### 8.1 Operation

The 'Partial Load Failure' (PLF) alarm detects an increase in load impedance due to the breakage, the destruction or the disconnection of the heating elements.

The PLF detection is indicated by red indicator light (light emitting diode) on front fascia.

Partial load failure detection changes the alarm relay state. The relay is de-energised in the alarm state, or when the ESwitch is not powered.

PLF Option: the contact is open in the alarm state.

IPF Option: the contact is closed in the alarm state.

Relay contact rating: 0.5A (250Vac or 30Vdc). Detection sensitivity of partial load failure: failure detection of 1 element for 6 identical parallel heater elements (for single-phase applications).

The PLF detection operates under the following conditions:

- Firing time  $\geq 1$ s
- Input signal duty cycle must be over 20%
- The on-time load current must be greater than:
  - 5A for 16A and 25A product
  - 8A for 40A product
  - 10A for 50A product

## 8.2 Setting up the PLF detection

**DANGER:** This operation must be performed by suitable qualified and trained personnel, authorized to work in an industrial low voltage environment.

The 'Partial Load Failure' (PLF) alarm detects an increase in load impedance. In order to carry out PLF adjustment, the current when fully conducting must be greater than:

- 5A for 16A and 25A product
- 8A for 40A product
- 10A for 50A product

As a general rule, since the load current is less than the unit's nominal current, the following setting must be carried out:

- Check that the thyristors are conducting (load current on and input green indicator light is illuminated)
- If the PLF detection red indicator light (identified on front fascia as 'LOAD FAILURE') is illuminated, turn the 25-turn PLF potentiometer (identified on front fascia as 'PLF ADJUST') anticlockwise until the PLF red indicator light switches off.
- Turn the potentiometer clockwise until the indicator lights comes on.
- Slowly turn back the potentiometer (anticlockwise) until the red indicator light is switched off.

The PLF detection control is now set to give maximum sensitivity.

If an erratic alarm appears, reduce the sensitivity by turning the potentiometer anticlockwise (e.g. quarter turn or more until the fault disappears).

Resetting the alarm is achieved either by removing power from the unit or by a returning to the previous load current.

## 9. THYRISTORS FIRING MODES - Logic mode

Power switches one, two or three zero crossings of the supply voltage after the logic input switches on. Power switches off two zero crossings of current after the logic input switches off. For resistive loads, voltage and current cross zero simultaneously.

Power on-off delay = two or three mains periods depending on where in the mains cycle the logic output changes state.

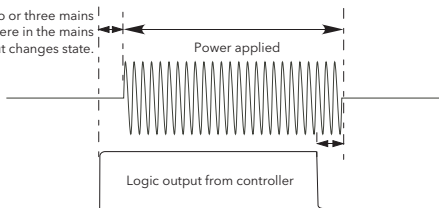

## 10. Current derating

**WARNING:** To reach the thermal performance the space gap between two ESwitch power contactors should be 10mm minimum.

**WARNING:** The product is designed to be mounted vertically. There must be no obstructions (above or below) which could reduce or hamper airflow. If more than one instance of the product is located in the same cabinet, they must be mounted in such a way that air from one unit is not drawn into another.

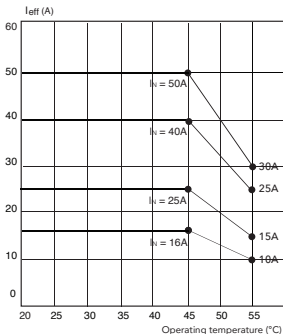

Current derating curves as a function of ambient temperature ( $I_N$  = nominal current at 45°C) for an altitude up to 1000m.

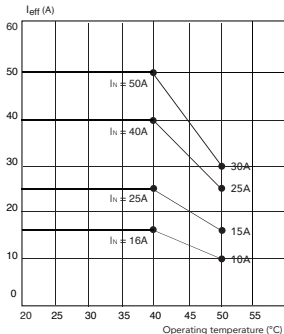

Current derating curves as a function of ambient temperature ( $I_N$  = nominal current at 40°C) for an altitude up to 2000m.

Eurotherm Limited  
Faraday Close, Durrington, Worthing  
West Sussex BN13 3PL United Kingdom  
Phone: +44 (0)1903 268500  
[www.eurotherm.co.uk](http://www.eurotherm.co.uk)



©2017 Schneider Electric. All Rights Reserved. All trademarks are owned by Schneider Electric Industries SAS or its affiliated companies.  
HA032323ENG Issue 3